



2025



КАТАЛОГ ПРОДУКЦІЇ

PRODUCTS CATALOG





ЗМІСТ



1. ОДНОКОМПОНЕНТНІ ТРЕ УЩІЛЬНЮВАЧІ ДЛЯ ПВХ ПРОФІЛІВ/*TPE SEAL STRIPS FOR PVC PROFILES*
2. ДВОКОМПОНЕНТНІ ТРЕ УЩІЛЬНЮВАЧІ ДЛЯ ПВХ ПРОФІЛІВ/*TPE SEAL STRIPS FOR PVC PROFILES*
3. ТРЕ УЩІЛЬНЮВАЧІ ДЛЯ МІЖКІМНАТНИХ ДВЕРЕЙ/*TPE SEAL STRIPS FOR INTERIOR DOORS*
4. ОДНЕ І ДВОКОМПОНЕНТНІ УЩІЛЬНЮВАЧІ ТРЕ ДЛЯ МЕТАЛЕВИХ ДВЕРЕЙ/*TPE SEAL STRIPS FOR METAL DOORS*
5. УЩІЛЬНЮВАЧІ ТРЕ ДЛЯ АЛЮМІНІЄВИХ СИСТЕМ/*TPE SEAL STRIPS FOR ALUMINUM SYSTEMS*
6. ПРОЗОРИ УЩІЛЬНЮВАЧІ ДЛЯ АЛЮМІНІЄВИХ СИСТЕМ/*TRANSPARENT SEAL STRIPS FOR ALUMINUM SYSTEMS*
7. УЩІЛЬНЮВАЧІ ТРЕ ДЛЯ МІЖКІМНАТНИХ ПЕРЕГОРОДОК/*TPE SEAL STRIPS FOR INTERIOR PARTITIONS*
8. УЩІЛЬНЮВАЧІ ДЛЯ ТЕПЛИЦЬ/*SEAL STRIPS FOR GREENHOUSE*
9. УЩІЛЬНЮВАЧІ ТРЕ ДЛЯ ПРОТИКОВЗКИХ ТА БРУДООЧИСНИХ СИСТЕМ/*SEAL STRIPS FOR ANTI-SLIP AND CLEANING SYSTEMS*
10. УЩІЛЬНЮВАЧІ ТРЕ ДЛЯ ПАВІЛЬЙОНІВ НА БАСЕЙН/*TPE SEAL STRIPS FOR POOL ENCLOSURES*
11. УЩІЛЬНЮВАЧІ PVC ДЛЯ НАТЯЖНИХ СТЕЛЬ/*PVC SEALING STRIPS FOR STRETCH CEILINGS*
12. УЩІЛЬНЮВАЧІ ТРЕ ДЛЯ МАШИНОБУДУВАННЯ/*SEAL STRIPS TPE FOR MECHANICAL ENGINEERING*
13. УЩІЛЬНЮВАЧ ДЛЯ ЗАХИСТУ ЛИТИХ ДИСКІВ/*SEAL STRIPS FOR PROTECTING ALLOY WHEELS*
14. ДОДАТКИ ДЛЯ ПВХ КОНСТРУКЦІЙ/*ACCESSORIES FOR PVC STRUCTURES*
15. ДЛЯ МЕБЛЕВОЇ ФУРНІТУРИ/*SEAL STRIPS FOR FURNITURE FITTINGS*
17. ДЛЯ РОЛЕТНИХ СИСТЕМ/*FOR ROLLER SHUTTER SYSTEMS*
18. ПВХ ПРОФІЛЬ СТІНОВИЙ/*PVC WALL PROFILE*
19. ЩІТКОВИЙ PP УЩІЛЬНЮВАЧ ДЛЯ РОЗСУВНИХ СИСТЕМ/*PILE WEATHERSTRIP FOR SLIDING SYSTEMS*



2025







Вид/ Item	Артикул/ Article	Кільк. м. у бухті/ M. on the coil	Вага г/м ±3%/ Weight g/m ±3%	Ширина/ Width	Висота/ Height	Шир. замка/ Width lock
--------------	---------------------	--------------------------------------	---------------------------------	------------------	-------------------	---------------------------



ADOPEX						
	KA-048 KA-048	300	57	14	11	5
	KA-155 KA-155	400	33	9	12	4.5

ARtec						
	KA-324 KA-324	400	33	9	12	6
	KA-325 KA-325	350	38	10	10	5



ALM plast						
	KA-144 KA-144	400	35	9.4	11.3	5
	KA-145 KA-145	400	36	9.8	9.6	4.8
	KA-1145 KA-1145	400	36	8.8	9.9	4.5

ALUPLAST						
	KA-053 KA-053	400	36	9.5	11	5
	KA-106 KA-106	350	46	7	11.5	4.7
	KA-156 KA-156	450	29	9	11	4
	KA-164 KA-164	400	35	10.5	9	4.5
	KA-306 KA-306	450	30	7.9	10.3	4.5





Вид/ Item	Артикул/ Article	Кільк. м. у бухті/ M. on the coil	Вага г/м ±3%/ Weight g/m ±3%	Ширина/ Width	Висота/ Height	Шир. замка/ Width lock
	KA-1305 KA-1305	400	41	9.5	9.5	4.5
	KA-2305 KA-2305	400	43	10	10	4.6

Brugmann						
	KA-136 KA-136	300	45	12.3	10	5



DECCO						
	KA-046 KA-046	400	35	8.5	11	5.2
	KA-178 KA-178	400	32	10.2	9	5.2
	KA-179 KA-179	400	33	9	11	5



Deceuninck Z.						
	KA-219 KA-219	450	41	8.5	11.5	4

DIMEX						
	KA-225 KA-225	400	37	10	9	5
	KA-324 KA-324	400	33	8.4	10.3	5.3
	KA-325 KA-325	350	38	10	10	5







Вид/ Item	Артикул/ Article	Кільк. м. у бухті/ M. on the coil	Вага г/м ±3%/ Weight g/m ±3%	Ширина/ Width	Висота/ Height	Шир. замка/ Width lock
--------------	---------------------	--------------------------------------	---------------------------------	------------------	-------------------	---------------------------

EcoPlast						
	KA-216 KA-216	400	33	10	10	4.7
	KA-217 KA-217	400	32	7.7	10.4	4.7

EXPROF						
	KA-031 KA-031	400	37	9.8	10	5
	KA-312 KA-312	400	34	9.5	11.3	5.5



FORIS						
	KA-046 KA-046	400	35	8.5	11	5.2





Framex						
	KA-017 KA-017	400	34	11.5	8.5	5.5
	KA-018 KA-018	450	32	8.5	10.5	5.5



GEALAN						
	KA-320 KA-320	400	33	10.2	9	5.2
	KA-1320 KA-1320	400	30	9.5	8.7	4.8
	KA-321 KA-321	450	31	9.5	10	3.5





Вид/ Item	Артикул/ Article	Кільк. м. у бухті/ M. on the coil	Вага г/м ±3%/ Weight g/m ±3%	Ширина/ Width	Висота/ Height	Шир. замка/ Width lock
--------------	---------------------	--------------------------------------	---------------------------------	------------------	-------------------	---------------------------



HOFFEN						
	KA-110 KA-110	400	32	12.4	10	5
	KA-111 KA-111	450	28	7.5	9.5	6

KBE						
	KA-031 KA-031	400	37	9.8	10	5
	KA-032 KA-032	400	41	10	10	5.1
	KA-125 KA-125	400	38	9.5	11.5	5
	KA-311 KA-311	400	42	10.2	10.9	4.8
	KA-312 KA-312	400	33	9.5	11.3	5.5



KÖMMERLING						
	KA-149 KA-149	380	48	9	11.5	5
	KA-150 KA-150	330	61	10	12	5
	KA-151 KA-151	450	30	8.5	11	4.5







KOMPEN						
	KA-052 KA-052	200	67	12	12	4.5
	KA-102 KA-102	400	32	7.7	10.4	4.7



Вид/ Item	Артикул/ Article	Кільк. м. у бухті/ M. on the coil	Вага г/м ±3%/ Weight g/m ±3%	Ширина/ Width	Висота/ Height	Шир. замка/ Width lock
	KA-110 KA-110	400	32	12.4	10	5
	KA-332 KA-332	400	35	12.5	8	5.5



Kenner						
	KA-136 KA-136	300	45	12.3	10	5



КТМ						
	KA-304 KA-304	450	30	8.3	10.2	5.2
	KA-2103 KA-2103	400	34	9.4	9.1	5
	KA-3304 KA-3304	450	29	7.8	9.2	4.8



Internova						
	KA-100 KA-100	400	33	11	8	5
	KA-101 KA-101	350	56	11	11	4.5
	KA-102 KA-102	400	32	7.7	10.4	4.7
	KA-155 KA-155	400	33	9	12	4.5
	KA-299 KA-299	400	31	8	9	4.5
	KA-300 KA-300	350	62	12	13	5







Вид/ Item	Артикул/ Article	Кільк. м. у бухті/ M. on the coil	Вага г/м ±3%/ Weight g/m ±3%	Ширина/ Width	Висота/ Height	Шир. замка/ Width lock
--------------	---------------------	--------------------------------------	---------------------------------	------------------	-------------------	---------------------------

LGC						
	KA-155 KA-155	400	33	9	12	4.5
	KA-320 KA-320	400	33	10.2	9	5.2



MASTER						
	KA-109 KA-109	400	33	7.5	9.5	4.5
	KA-151 KA-151	450	30	8.5	11	4.5



MONTBLANC						
	KA-304 KA-304	450	30	8.3	10.2	5.2
	KA-2303 KA-2303	400	38	8.2	8.7	



NEXT						
	KA-017 KA-017	400	34	11.5	8.5	5.5
	KA-018 KA-018	450	31	8.5	10.5	5.5
	KA-225 KA-225	400	37	10	9	5
	KA-229 KA-229	450	31	9	10.5	5.5
	KA-333 KA-333	400	38	11	9.6	5.1







Вид/ Item	Артикул/ Article	Кільк. м. у бухті/ M. on the coil	Вага г/м ±3%/ Weight g/m ±3%	Ширина/ Width	Висота/ Height	Шир. замка/ Width lock
--------------	---------------------	--------------------------------------	---------------------------------	------------------	-------------------	---------------------------

Prokal						
	KA-021 KA-021	400	42	11	9	4.5
	KA-142 KA-142	400	36	10	11.5	4.5

PLAFEN						
	KA-046 KA-046	400	35	8.5	11	5.2
	KA-247 KA-247	350	49	11.5	11	4.5

ProfiLink						
	KA-055 KA-055	400	40	10.5	9	5
	KA-227 KA-227	400	36	9.6	11	5.2



Pакpen						
	KA-021 KA-021	400	42	11	9	4.5
	KA-318 KA-318	450	31	10	9	4.5



Openteck						
	KA-304 KA-304	450	30	8.3	10.2	5.2
	KA-2103 KA-2103	400	34	9.4	9.1	5









Вид/ Item	Артикул/ Article	Кільк. м. у бухті/ M. on the coil	Вага г/м ±3%/ Weight g/m ±3%	Ширина/ Width	Висота/ Height	Шир. замка/ Width lock
--------------	---------------------	--------------------------------------	---------------------------------	------------------	-------------------	---------------------------

PLUSTEC						
	KA-146 KA-146	400	31	9.6	11	5.2

Roplasto						
	KA-225 KA-225	400	37	10	9	5
	KA-229 KA-229	450	31	9	10.5	5.5





LG Chem						
	KA-128 KA-128	400	40	10	9.5	4.5
	KA-129 KA-129	400	37	9	7.5	4
	KA-208 KA-208	400	46	9.4	11.3	5



REHAU						
	KA-304 KA-304	450	30	8.3	10.2	5.2
	KA-304/1 KA-304/1	450	31	8.5	10.5	5.3
	KA-1303 KA-1303	400	34	8.8	9.5	5.4
	KA-2303 KA-2303	400	38	8.2	8.7	
	KA-3103 KA-3103	400	35	10	9	4.8
	KA-4103 KA-4103	400	33	10.5	9.1	4.3





Вид/ Item	Артикул/ Article	Кільк. м. у бухті/ M. on the coil	Вага г/м ±3%/ Weight g/m ±3%	Ширина/ Width	Висота/ Height	Шир. замка/ Width lock
--------------	---------------------	--------------------------------------	---------------------------------	------------------	-------------------	---------------------------

SARPLAST						
	KA-172 KA-172	350	36	9.5	11.5	5.5

Steko						
	KA-023 KA-023	400	35	8.7	8.5	5
	KA-024 KA-024	400	34	11.5	10	5
	KA-024/1 KA-024/1	400	37	11.6	10.4	4.9
	KA-046 KA-046	400	35	8.5	11	5.2
	KA-145 KA-145	400	36	9.8	9.6	4.8
	KA-153 KA-153	400	33	8.4	12.1	4.4







SALAMANDER						
	KA-144 KA-144	400	35	9.4	11.3	5
	KA-145 KA-145	400	36	9.8	9.6	4.8
	KA-1145 KA-1145	400	36	8.8	9.9	4.5

THYSSEN						
	KA-209 KA-209	400	40	8	8	4
	KA-210 KA-210	500	24	7	7.6	4.5





Вид/ Item	Артикул/ Article	Кільк. м. у бухті/ M. on the coil	Вага г/м ±3%/ Weight g/m ±3%	Ширина/ Width	Висота/ Height	Шир. замка/ Width lock
--------------	---------------------	--------------------------------------	---------------------------------	------------------	-------------------	---------------------------



Trocal						
	KA-227 KA-227	400	36	9.6	11	5.2





VEKA Softline						
	KA-049 KA-049	300	45	10.5	11	6
	KA-313 KA-313	400	36	10	9	6
	KA-315 KA-315	400	32	10	11	5.8
	KA-319 KA-319	400	33	9	12	6
	KA-1313 KA-1313	400	40	10.6	9	5.4
	KA-1314 KA-1314	300	43	13.8	9.3	5.6
	KA-1315 KA-1315	300	43	17.4	9.7	5.6



WDS						
	KA-1511 KA-1511	400	40	8	7.5	4.5

Winbau (Tepla)						
	KA-022 KA-022	400	36	10	9.5	4.5
	KA-144 KA-144	400	35	9.4	11.3	5
	KA-145 KA-145	400	36	9.8	9.6	4.8





Вид/ Item	Артикул/ Article	Кільк. м. у бухті/ M. on the coil	Вага г/м ±3%/ Weight g/m ±3%	Ширина/ Width	Висота/ Height	Шир. замка/ Width lock
	KA-251 KA-251	400	46	10	10	5
	KA-2103 KA-2103	400	34	9.4	9.1	5



Wintech						
	KA-144 KA-144	400	35	9.4	11.3	5
	KA-145 KA-145	400	36	9.8	9.6	4.8
	KA-1145 KA-1145	400	36	8.8	9.9	4.5
	KA-155 KA-155	400	33	9	12	4.5



WEISS						
	KA-2303 KA-2303	400	38	8.2	8.7	
	KA-304 KA-304	450	30	8.3	10.2	5.2



Wymar						
	KA-211 KA-211	400	31	11	11	5



Windoff's						
	KA-144 KA-144	400	35	9.4	11.3	5
	KA-145 KA-145	400	36	9.8	9.6	4.8



Вид/ Item	Артикул/ Article	Кільк. м. у бухті/ M. on the coil	Вага г/м ±3%/ Weight g/m ±3%	Ширина/ Width	Висота/ Height	Шир. замка/ Width lock
	KA-320 KA-320	400	33	10.2	9	5.2
	KA-324 KA-324	400	33	8.4	10.3	5.3

















WELTPLAST						
	KA-154 KA-154	400	33	7.5	9.5	4.5
	KA-155 KA-155	400	33	9	12	4.5
	KA-304 KA-304	450	30	8.3	10.2	5.2

Winhouse						
	KA-318 KA-318	450	31	10	9	4.5
	KA-326 KA-326	380	38	11	10.5	4.5

















Викнар'off						
	KA-1111 KA-1111	450	27	7.5	9.5	6
	KA-1216 KA-1216	380	38	11	10	4.8
	KA-1324 KA-1324	400	32	8.5	10	4.8

ОКОШКО						
	KA-1154 KA-1154	350	40	8.8	10.5	5



Вид/ Item	Артикул/ Article	Кільк. м. у бухті/ M. on the coil	Вага г/м ±3%/ Weight g/m ±3%	Ширина/ Width	Висота/ Height	Шир. замка/ Width lock
	СК-01 SC-01	800	33	10.5	12.5	5.3
	СК-02 SC-02	800	31	9.4	13.5	5
	СК-02/1 SC-02/1	900	30	9	12.8	4.5
	СК-03 SC-03	900	30	9	10	5
	СК-04 SC-04	800	33	10.5	10.5	5.6
	СК-05 SC-05	800	34	11.3	9.6	4.9
	СК-05/1 SC-05/1	800	33	11.8	9.7	5.3
	СК-06 SC-06	800	31	10	10.5	5.5
	СК-06/1 SC-06/1	800	30	10	9.5	4.8
	СК-07 SC-07	900	31	12	9.5	4
	СК-08/1 SC-08/1	1000	27	10	9	4.6
	СК-08/2 SC-08/2	1000	28	11	9	4.6
	СК-09 SC-09	800	27	11	9.8	4.4
	СК-10 SC-10	900	28	9	10.5	4.5
	СК-11 SC-11	900	27	8.8	10	4.4
	СК-15 SC-15	800	33	10.5	9.8	4.8



















Вид/ Item	Артикул/ Article	Кільк. м. у бухті/ M. on the coil	Вага г/м ±3%/ Weight g/m ±3%	Ширина/ Width	Висота/ Height	Шир. замка/ Width lock
	СК-16 SC-16	900	27	9.4	11	5
	СК-19 SC-19	900	29	10.8	9.2	4.4
	СК-19/1 SC-19/1	900	28	10	8.8	4.3
	СК-20 SC-20	800	30	12	9.5	4
	СК-21 SC-21	900	28	7.7	11.8	4.6
	СК-22 SC-22	900	29	8.1	10	5.1
	СК-22/1 SC-22/1	800	31	10.7	9.8	4.1
	СК-23 SC-23	800	28	10	10.25	5
	СК-24 SC-24	800	30	11	8.7	5
	СК-25 SC-25	800	33	12	11	5.2
	СК-26 SC-26	800	35	10.5	10	5
	СК-27 SC-27	800	33	10	10.5	5.2
	СК-28 SC-28	800	33	12	10.5	5.5
	СК-29 SC-29	800	31	8.5	10.3	5.1
	СК-30 SC-30	800	35	11.8	8.8	4.5
	СК-31 SC-31	900	26	8.8	10.5	5.1

















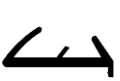

Вид/ Item	Артикул/ Article	Кільк. м. у бухті/ M. on the coil	Вага г/м $\pm 3\%$ / Weight g/m $\pm 3\%$	Ширина/ Width	Висота/ Height	Шир. замка/ Width lock
	СК-32 SC-32	800	28	9.2	8.9	4.2



Вид/ Item	Артикул/ Article	Кільк. м. у бухті/ M. on the coil	Вага г/м ±3%/ Weight g/m ±3%	Ширина/ Width	Висота/ Height	Шир. замка/ Width lock
	ДР-700 DR-700	200	44	10	14.3	5.0
	ДР-701 DR-701	250	32	8	12.4	5
	ДР-702 DR-702	300	21	7.7	10	3.8
	ДР-703 DR-703	200	55	16.3	8	5.7
	ДР-703/1 DR-703/1	150	70	18.2	8.7	6.6
	ДР-704 DR-704	300	26	8.2	7.5	7.2
	ДР-706 DR-706	450	28	7	7.5	4
	ДР-707 DR-707	300	23	6	11.8	4
	ДР-708 DR-708	300	40	11	11	5
	ДР-709 DR-709	200	45	10	10	5
	ДР-710 DR-710	300	41	9.1	11.2	4.2
	ДР-711 DR-711	300	39	10.8	11	3.8
	ДР-711/1 DR-711/1	300	32	9.1	9.5	3.2
	ДР-712 DR-712	500	22	5.5	5.5	3
	ДР-714 DR-714	200	54	13.7	14.3	4.7
	ДР-7140 DR-7140 (TPE)	200	43	15.4	15.6	4.5



Вид/ Item	Артикул/ Article	Кільк. м. у бухті/ M. on the coil	Вага г/м ±3%/ Weight g/m ±3%	Ширина/ Width	Висота/ Height	Шир. замка/ Width lock
	ДР-7141 DR-7141	200	53	14.4	15.8	4.3
	ДР-7141/1 DR-7141/1	200	51	12.8	15	4.3
	ДР-714/1 DR-714/1	250	58	11.6	12.8	3.8
	ДР-714/2 DR-714/1	250	48			
	ДР-715 DR-715	150	33	8	17	7
	ДР-716 DR-716	300	39	11.2	10.4	4.6
	ДР-716/1 DR-716/1	300	37	10.6	10.9	4.3
	ДР-717 DR-717	100/400	21	7.5	8.5	2.8
	ДР-718 DR-718	250	47	18.7	8.4	6.8
	ДР-719 DR-719	400	31	9.5	8.5	4.4
	ДР-720 DR-720	200	56	18.5	8.5	11.5
	ДР-721 DR-721	150	58	17.4	11.2	
	ДР-722 DR-722	350	39	15.5	5.3	4.8
	ДР-723 DR-723	350	34	13.5	7.5	
	ДР-724 DR-724	200	40	13.5	14	4.5
	ДР-725 DR-725	200	45	12.7	13	4.2

















	ДР-725/1 DR-725/1	200	44	11.8	14.6	4
---	-----------------------------	------------	-----------	-------------	-------------	----------













Вид/ Item	Артикул/ Article	Кільк. м. у бухті/ M. on the coil	Вага г/м ±3%/ Weight g/m ±3%	Ширина/ Width	Висота/ Height	Шир. замка/ Width lock
	ДР-726 DR-726	200	48	17.7	6.5	3.2
	ДР-727 DR-727	200	44	12	10.7	4
	ДР-728 DR-728	400	36	6	8.5	2.6
	ДР-729 DR-729	250	58	18	14	5
	ДР-730 DR-730	350	38	10.4	10	4
	ДР-731 DR-731	350	26	7.8	9.3	3.7
	ДР-731/1 DR-731	350	29	7.9	9.5	4.4
	ДР-732 DR-732	350	36	9.7	9.1	3.5
	ДР-734 DR-734	200	58	18.5	8.5	6.5
	ДР-739 DR-739	200	51	15.2	17.5	4.2
	ДР-739/1 DR-739/1	200	57	16.8	15.4	4.7
	ДР-7392 DR-7392	200	44	11.5	14.5	3.7
	ДР-740 DR-740	200	52	18	7	4
	ДР-745 DR-745	450	27	8.5	6.8	3.6
	ДР-747 DR-747 (ПВХ)	200	50	16	7.4	3.4
	ДР-747 DR-747 (ТПЕ)	200	39	15.2	6.2	3.1

































Вид/ Item	Артикул/ Article	Кільк. м. у бухті/ M. on the coil	Вага г/м ±3%/ Weight g/m ±3%	Ширина/ Width	Висота/ Height	Шир. замка/ Width lock
	ДР-750 DR-750	250	42	17.8	7	5.4
	ДР-751 DR-751	400	26	8.7	7.7	4
	ДР-752 DR-752	250	39	12.2	14.7	4.8
	ДР-753 DR-753	250	53	17.5	10	7
	ДР-754 DR-754	300	39	11	11.2	4
	ДР-756 DR-756	300	45	15.4	6.8	3.5
	ДР-756/1 DR-756/1	300	38	14.4	7	5.6
	ДР-759 DR-759	200	62	17.5	8.9	6
	ДР-760 DR-760	350	41	11.4	10.8	4.2
	ДР-761 DR-761	250	48	16.2	7.6	3.6
	ДР-762 DR-762	250	42	17.4	7.6	5.5
	ДР-7201 DR-7201	250	51	18.4	8.3	6.1
	ДР-7301 DR-7301	350	36	10.4	9.1	4.8
	ДЛ-001 DL-001	2.5/250	26	6.2	4.5	









Вид/ Item	Артикул/ Article	Кільк. м. у бухті/ M. on the coil	Вага г/м ±3%/ Weight g/m ±3%	Ширина/ Width	Висота/ Height	Шир. замка/ Width lock
	СД-708 SD-708	800	33	10	10.2	4.2
	СД-710 SD-710	800	37	10.2	9.8	3.7
	СД-735 SD-735	800		14	5.7	3
	СД-735/1 SD-735/1	800		16.3	6.2	3.3
	СД-736 SD-736	800	34	10	12.5	4
	СД-741 SD-741	250	44	16.2	7.8	4.3
	СД-742 SD-742	під замовлення/ on order	30	7	8.3	5.1
	СД-7421 SD-7421	2.150	29	7	7.3	3.9
	СД-743 SD-743	250	46	16	8	4
	СД-748 SD-748	300	24	7.8	9.6	3.9





Вид/ Item	Артикул/ Article	Кільк. м. у бухті/ M. on the coil	Вага г/м ±3%/ Weight g/m ±3%	Ширина/ Width	Висота/ Height	Шир. замка/ Width lock
	ПУ-55/22 РА-55/22	250	39	11.7	6.7	5
	ПУ-522 РА-522	300	62	12	9.4	5.2
	ПУ-552 РА-552	250	44	11	7.5	5
	ПУ-558 РА-558	300	32	7	6	3
	ПУ-558/1 РА-558/1	300	44	7	8	4
	ПУ-559 РА-559	200	60	9	8	4
	ПУ-565 РА-565	200	56	8	13	
	ПУ-572 РА-572	500	19	4	8	3.7
	ПУ-578/3 РА-578/3	300	48	10	8	3
	ПУ-598 РА-598	250	84	9.1	12.1	4.6
	ПУ-613 РА-613	200	78	9.1	12.3	5.1
	ПУ-613/1 РА-613/1	200	75	10.5	13.2	5.6
	ПУ-634 РА-634	200	35	8	6.8	6.1
	ПУ-634/1 РА-634/1	200	42	10.3	7.3	6.2
	ПУ-635 РА-635	300	42	10.9	8.5	6.5
	ПУ-637 РА-637	250	22	7.4	5.8	4





Вид/ Item	Артикул/ Article	Кільк. м. у бухті/ M. on the coil	Вага г/м ±3%/ Weight g/m ±3%	Ширина/ Width	Висота/ Height	Шир. замка/ Width lock
	ПУ-638 РА-638	300	53	10.4	11.3	4
	ПУ-639 РА-639	250	64	11.4	11.9	4
	ПУ-646 РА-646	250	57	10.5	10.5	4
	ПУ-648 РА-648	250	53	11.4	9.5	4
	ПУ-648/1 РА-648/1	250	48	11	9	4
	ПУ-650 РА-650	300	39	11.5	7.5	4
	ПУ-670 РА-670	300	47		12.6	3.2
	ПУ-671 РА-671	400	38	5.7	9.2	2.7
	ПУ-678 РА-678	350	51	10	7.5	4
	ПУ-680 РА-680	350	40	12.5	10	8.6
	ПУ-690 РА-690	250	52	10.2	9.6	4
	ПУ-691 РА-691	300	47	10	11	4
	ПУ-691/1 РА-691/1	300	54			
	ПУ-692 РА-692	450	24	9	6.5	6.6







Вид/ Item	Артикул/ Article	Кільк. м. у бухті/ M. on the coil	Вага г/м ±3%/ Weight g/m ±3%	Ширина/ Width	Висота/ Height	Шир. замка/ Width lock
	ДМ-01 DM-01	500	20	8.7	6	
	ДМ-03 DM-03	600	13	6.1	5	
	ДР-025 DR-025	150	80	21.5	8.2	6.6
	ДР-025/1 DR-025/1	150	57	17.7	7.1	6.6
	ДР-746 DR-746	300	40	11.3	11.5	3.8
	СД-705 SD-705	800	32	13.4	7	



Вид/ Item	Артикул/ Article	Кільк. м. у бухті/ M. on the coil	Вага г/м ±3%/ Weight g/m ±3%	Ширина/ Width	Висота/ Height	Шир. замка/ Width lock
--------------	---------------------	--------------------------------------	---------------------------------	------------------	-------------------	---------------------------

Alumil						
	ПУ-532 РА-532	200	55	14	8	4.5
	ПУ-538 РА-538	250	42	7	13	







Aluline						
	ПУ-540 РА-540	300	15	5.4	6.4	
	ПУ-548 РА-548	170	77	13	7.5	8
	ПУ-553 РА-553	50	159	37.9	20.5	
	ПУ-555 РА-555	300	44	12	6	



AluTech						
	ПУ-047 РА-047	450	30	7	6	4
	ПУ-564 РА-564	200	60	10	14	
	ПУ-570 РА-570	250	55	11	12	4.5
	ПУ-571 РА-571	250	50	15	6.5	3.5
	ПУ-573 РА-573	400	41	10	6.5	2.5
	ПУ-609 РА-609	250	32	11	7.5	5.5
	ПУ-610 РА-610	150	78	11	8	7.5





Вид/ Item	Артикул/ Article	Кільк. м. у бухті/ M. on the coil	Вага г/м ±3%/ Weight g/m ±3%	Ширина/ Width	Висота/ Height	Шир. замка/ Width lock
--------------	---------------------	--------------------------------------	---------------------------------	------------------	-------------------	---------------------------

	ПУ-611 РА-611	100	147	10.5	16	7.5
---	-------------------------	------------	------------	-------------	-----------	------------













АМТТ						
	ПУ-640 РА-640	230	60	14.2	9.8	6.6
	ПУ-641 РА-641	120	81	14.2	11.8	6.6
	ПУ-643 РА-643	120	140	14	12.75	6.3
	ПУ-644 РА-644	250	44	16.7	7.7	8.2
	ПУ-645 РА-645	400	38	10.7	7.3	4.8
	ПУ-647 РА-647	380	37	12	5.8	3.5



ASAS						
	ПУ-602 РА-602	300	35	7	9	4.5
	ПУ-603 РА-603	50	263	30	16	29

Balkan						
	ПУ-508 РА-508	200	74	15.7	8.6	7.6
	ПУ-510 РА-510	250	49	12.2	6	7









Вид/ Item	Артикул/ Article	Кільк. м. у бухті/ M. on the coil	Вага г/м ±3%/ Weight g/m ±3%	Ширина/ Width	Висота/ Height	Шир. замка/ Width lock
--------------	---------------------	--------------------------------------	---------------------------------	------------------	-------------------	---------------------------







Elvial						
	ПУ-500 РА-500	400	39	6	10	5
	ПУ-502 РА-502	100	155	13.6	18.3	
	ПУ-503 РА-503	200	56	9.5	13.7	
	ПУ-504 РА-504	250	56	9	11	
	ПУ-505 РА-505	500/100	25	5.4	9.4	
	ПУ-545 РА-545	300	38	6.7	12.1	
	ПУ-561 РА-561	350	52	11	9	5
	ПУ-601 РА-601	400	24	7	9	4.5
	ПУ-617 РА-617	150	78	15	11	5
	ПУ-618 РА-618	150	130	10	17	6
	ПУ-619 РА-619	150	95	14	11	6
	ПУ-620 РА-620	150	99	16	12	6

Finish						
	ПУ-531 РА-531	150	130	9	14.5	5
	ПУ-605 РА-605	350	38	10.2	8.2	3.8





Вид/ Item	Артикул/ Article	Кільк. м. у бухті/ M. on the coil	Вага г/м ±3%/ Weight g/m ±3%	Ширина/ Width	Висота/ Height	Шир. замка/ Width lock
	ПУ-606 РА-606	250	36	12	8	6.5
	ПУ-607 РА-607	230	60	16	10	6
	ПУ-608 РА-608	800/500	24	4.5	5	4





Provedal						
	ПУ-534 РА-534	150	88	11.5	17.5	4
	ПУ-535 РА-535	150	85	13	18	4
	ПУ-536 РА-536	300	42	12	6	3.5
	ПУ-609 РА-609	250	29	11	7.5	5.5

Saray						
	ПУ-047 РА-047	450	30	7	6	4
	ПУ-523 РА-523	300	51	14	7	3
	ПУ-524 РА-524	300	39	10	7	6.5
	ПУ-540 РА-540	300	15	5.4	6.4	
	ПУ-541 РА-541	300	40	15	8	2.8
	ПУ-544 РА-544	600/150	14	6.5	5	



Вид/ Item	Артикул/ Article	Кільк. м. у бухті/ M. on the coil	Вага г/м ±3%/ Weight g/m ±3%	Ширина/ Width	Висота/ Height	Шир. замка/ Width lock
	ПУ-560 РА-560	250	52	12	8	
	ПУ-563 РА-563	200	58	13.6	8.7	3.3
	ПУ-570 РА-570	250	55	12	11	4.5
	ПУ-571 РА-571	250	50	15	6.5	3.5











Reynaers						
	ПУ-526 РА-526	150	74	13	10	6
	ПУ-527 РА-527	100	135	12	13	6
	ПУ-580 РА-580	100	140	15	15.5	6.5

Yawal						
	ПУ-567 РА-567	250	58	9.5	7	3.5
	ПУ-568 РА-568	230	62	9.5	8	3.5
	ПУ-569 РА-569	150	90	9.5	12	3.5
	ПУ-612 РА-612	200	73	16	10	7.8



Steko						
	ПУ-511 РА-511	200	28	7.7	7.3	3.8













Вид/ Item	Артикул/ Article	Кільк. м. у бухті/ M. on the coil	Вага г/м ±3%/ Weight g/m ±3%	Ширина/ Width	Висота/ Height	Шир. замка/ Width lock
	ПУ-523 РА-523	300	51	14	7	3
	ПУ-605 РА-605	350	38	10	8.2	3.8
	ПУ-695 РА-695	400	33	12	7.4	4
	ПУ-696 РА-696	150	99	17.6	11.7	5

Зенит						
	ПУ-576 РА-576	250	44	15	9	5
	ПУ-577 РА-577	200	46	16	7.5	7
	ПУ-579 РА-579	200	51	10	13.5	6
	ПУ-581 РА-581	250	38	6	12	4
	ПУ-584 РА-584	350	23	6	6.5	5
	ПУ-585 РА-585	250	42	10.5	6	4.5
	ПУ-586 РА-586	200	55	13	10	5.5
	ПУ-587 РА-587	250	37	10	9	4.5
	ПУ-588 РА-588	200	78	21	9	6
	ПУ-589 РА-589	100	86	15.5	11	6
	ПУ-591 РА-591	90	172	34	20.5	6





Вид/ Item	Артикул/ Article	Кільк. м. у бухті/ M. on the coil	Вага г/м ±3%/ Weight g/m ±3%	Ширина/ Width	Висота/ Height	Шир. замка/ Width lock
	ПУ-592 РА-592	100	107	14	19	6
	ПУ-593 РА-593	70	140	46	9.5	6

Талисман						
	ПУ-047 РА-047	450	30	7	6	4
	ПУ-047/1 РА-047/1	450	24	7.4	6.6	3.7
	ПУ-520 РА-520	250	52	14	7	4
	ПУ-521 РА-521	500	32	10	5.3	3
	ПУ-556 РА-556	500	31	11.5	8	4
	ПУ-606 РА-606	250	40	12	8	6.5

Текно						
	ПУ-597 РА-597	170	83	11.7	15.3	9
	ПУ-621 РА-621	350	28	11.5	7	4
	ПУ-622 РА-622	100	150	18	12	5.5
	ПУ-623 РА-623	200	80	23	7.5	



















Вид/ Item	Артикул/ Article	Кільк. м. у бухті/ M. on the coil	Вага г/м ±3%/ Weight g/m ±3%	Ширина/ Width	Висота/ Height	Шир. замка/ Width lock
Інше						
	ПУ-501 РА-501	600	24	10	4.7	4.7
	ПУ-501/1 РА-501/1	600	29	10.7	5.65	5
	ПУ-506 РА-506	250	40	12	8	5.5
	ПУ-509 РА-509	350	20	7.2	4.6	1.8
	ПУ-514 РА-514	350	26	7	7	
	ПУ-525 РА-525	200	70	9.5	15	4
	ПУ-604 РА-604	300	42	11	3	
	ПУ-605/1 РА-605/1	350	44	9	8.1	3.7
	ПУ-614 РА-614	100/600	25	5	5	2
	ПУ-616 РА-616	50/150	51	12	10	
	ПУ-624 РА-624	50/150	70	14	11.5	
	ПУ-651 РА-651	300	52	11	8	9
	ПУ-664 РА-664	250	32	8	8.8	
	ПУ-665 РА-665	300	20	8.5	4	
	ПУ-7000 РА-7000	200	60	10.8	8.7	4.1



















Вид/ Item	Артикул/ Article	Кільк. м. у бухті/ M. on the coil	Вага г/м $\pm 3\%$ / Weight g/m $\pm 3\%$	Ширина/ Width	Висота/ Height	Шир. замка/ Width lock
	ПУ-5401 PA-5401	300	27	6.8	8.5	
	СД-8001 SD-8001	800	31	12.5	7	4.7
	СД-8002 SD-8002	800	21	6.5	7.7	4.7



















Вид/ Item	Артикул/ Article	Кільк. м. у бухті/ M. on the coil	Вага г/м ±3%/ Weight g/m ±3%	Ширина/ Width	Висота/ Height	Шир. замка/ Width lock
	ПУ-539 РА-539	250	67	10.3	11.9	3.6
	ПУ-546 РА-546	300	53	11	8.4	3
	ПУ-547 РА-547	150	99	10	15	4.1
	ПУ-550 РА-550	300	36	11.6	7.3	4
	ПУ-5501 РА-5501	300	40	11.2	6.4	4
	ПУ-5507 РА-5507	300/350	34	10.8	6.7	4
	ПУ-5508 РА-5508	300	35	10.7	7	4
	ПУ-5509 РА-5509	300	37	10.8	7	4
	ПУ-5509/3 РА-5509/3	300	39	11.35	7.3	4
	ПУ-5510 РА-5510	350	30	10.6	6.7	4
	ПУ-5511 РА-5511	250	26	11.8	4.8	4
	ПУ-5513 РА-5513	200	55	10.8	8.2	4
	ПУ-5514 РА-5514	350	30	10	7	4
	ПУ-5515 РА-5515	300	38	11.2	7.3	3
	ПУ-551 РА-551	300	44	10	8.5	4
	ПУ-599 РА-599	100/400	18	6.5	6.5	4



Вид/ Item	Артикул/ Article	Кільк. м. у бухті/ M. on the coil	Вага г/м ±3%/ Weight g/m ±3%	Ширина/ Width	Висота/ Height	Шир. замка/ Width lock
	ПУ-600 РА-600 PVC	100/500	21	7	5	
	ПУ-600 РА-600 ТЕР	100/500	17	7	5	
	ПУ-600/1 РА-600/1	100/500	18	7	6	
	ПУ-600/2 РА-600/2	100/500	14	6.5	4.6	
	ПУ-600/3 РА-600/3	100/400	21	7.7	5.4	
	ПУ-600/4 РА-600/4	100/400	24	7.5	5.3	
	ПУ-600/5 РА-600/5	150	16	6.6	4.6	
	ПУ-615/3 РА-615/3	300	46	11	7	3
	ПУ-615/5 РА-615/5	300	42	10.6	7.6	4
	ПУ-636 РА-636	250	51	8.9	10	5.7
	ПУ-662 РА-662	300	46	10.2	8.5	5.8
	ПУ-663 РА-663	800	16	7.5	3.5	1.5
	ПУ-667 РА-667	100/600	7	6	2.5	
	ПУ-668 РА-668	200	25	11.5	7.3	8
	ПУ-672 РА-672	500	15	7.3	6.9	6
	ПУ-679 РА-679	200	40	8	7.5	4













Вид/ Item	Артикул/ Article	Кільк. м. у бухті/ M. on the coil	Вага г/м ±3%/ Weight g/m ±3%	Ширина/ Width	Висота/ Height	Шир. замка/ Width lock
	ПУ-681 РА-681	200	43	10	7.3	3.5
	ПУ-682 РА-682	350	41	6	19	4
	ПУ-683 РА-683	200	60	9.5	8.5	4
	ПУ-684 РА-684	250	50	10	9.1	4
	ПУ-685 РА-685	150/1000	16	4.5	6	1.3
	ПУ-686 РА-686	800	18	11	1.7	
	ПУ-687 РА-687	150	95	13	17	9.5
	ПУ-688 РА-688	100	130	13.5	16.8	8.5
	ПУ-697 РА-697	150	12	4.5	4.7	1.4
	ПУ-698 РА-698	200	30	11	6.2	6
	ПУ-698/1 РА-698/1	200	27	10.5	5.7	6
	ПУ-699 РА-699	200	40	10.9	8.4	6
	ПУ-7001 РА-7001	150/900	13	4.3	4.6	
	ПУ-7002 РА-7002	250/400	27	10.3	8	8.7
	ПУ-7004 РА-7004	100/500	12	5.8	4.2	3
	ПУ-7005 РА-7005	100/500	21	6.2	6	



Вид/ Item	Артикул/ Article	Кільк. м. у бухті/ M. on the coil	Вага г/м ±3%/ Weight g/m ±3%	Ширина/ Width	Висота/ Height	Шир. замка/ Width lock
	ПУ-7006 РА-7006	300	7	Ø3		
	ПУ-7008 РА-7008	200/1000	14	4.5	6.4	
	ПУ-6155 РА-6155	300	43			
	СА-40 СА-40	3.0x180	17	6.8	5.8	

































Вид/ Item	Артикул/ Article	Кільк. м. у бухті/ M. on the coil	Вага г/м ±3%/ Weight g/m ±3%	Ширина/ Width	Висота/ Height	Шир. замка/ Width lock
	МП-001 MP-001	400	33	7.9	6.5	2.5
	МП-002 MP-002	300	50	9.5	7.6	2.8
	МП-003 MP-003	400	36	12.8	5.8	
	МП-003м MP-003m	400	34	11.4	5.3	
	МП-1001 MP-1001	120	126	22.8	7.5	20
	МП-1002 MP-1002	350	41	10.4	8.4	6.2
	МП-1003 MP-1003	500	34	5.7	12.5	2.7
	МП-1004 MP-1004	350	41	9.5	11.4	3.3
	МП-1005 MP-1005	800	15	5.4	7	3.3
	МП-1006 MP-1006	150	84	23.8	7.3	12.2
	МП-1007 MP-1007	250	60	15.4	13.2	6.8









Вид/ Item	Артикул/ Article	Кільк. м. у бухті/ M. on the coil	Вага г/м ±3%/ Weight g/m ±3%	Ширина/ Width	Висота/ Height	Шир. замка/ Width lock
	ПУ-506 РА-506	250	40	12	8	5.5
	ПУ-606 РА-606	250	39	12	8	6.5
	ПУ-689 РА-689	400	36	10	5	2.2
	ПУ-693 РА-693	100	148	56	6	24
	ПУ-694 РА-694	80	175	60.5	3.5	19.5

















Вид/	Артикул/	Кільк. м. у бухті/	Вага г/м ±3%/	Ширина/	Висота/	Шир. замка/
	ПС-800 PS-800	170	164	8.6	21.7	6
	ПС-806 PS-806	150	93	35	4.5	3
	ПС-806/1 PS-806/1 (self-adhesive)	1	138	40	4.5	4.5
	ПС-807 PS-807	100	155	40	10	
	ПС-807/1 PS-807/1	100	124	35	9	2
	ПС-808 PS-808	200	88	26	5	4
	ПС-809 PS-809	80	222	28	11	23
	ПС-810 PS-810	250	75	17	5	2.5
	ПС-810/1 PS-810/1	250	59	16.8	5	2
	ПС-811 PS-811	1000	29	8	3	
	ПС-812 PS-812	250	64	24	5	
	ПС-813 PS-813	100	-	26	10	21
	ПС-814 PS-814	130	127	30	6.5	
	ПС-815 PS-815	150	110	30.5	5.5	
	ПС-815/1 PS-815/1	150	93	27.7	4.35	
	ПС-816 PS-816	150	171	29	5	

















Вид/	Артикул/	Кільк. м. у бухті/	Вага г/м $\pm 3\%$ /	Ширина/	Висота/	Шир. замка/
	ПС-817 PS-817	200	87	31.3	4.6	2.0
	ПС-818 PS-818	200	80	29.8	4.7	1.8
	ПС-819 PS-819	80	193	26.2	11.2	23.3
	ПС-820 PS-820	150	82	10.4		
	ПС-821 PS-821	100	111	31.6	4.7	
	ПС-822 PS-822	100	125	14.8	11	4.4
	ПС-823 PS-823	80	145	34.9	9.3	
	ПС-823/1 PS-823/1	150	90	29.3	7.4	
	ПС-824 PS-824	130	145	34.8	4.5	
	ПС-825 PS-825	100	130	28.3	6.0	22
	ПС-826 PS-826	100	160	42.8	5.4	
	ПС-827 PS-827	50	230	31.7	11.6	23.5
	ПС-830 PS-830	200	94	23	3.5	
	ПС-831 PS-831	80	182	25	9.2	5
	ПС-832 PS-832	130	100	13.8	10.7	13.5

Вид/ Item	Артикул/ Article	Кільк. м. у бухті/ M. on the coil	Вага г/м ±3%/ Weight g/m ±3%	Ширина/ Width	Висота/ Height	Шир. замка/ Width lock
	ПУ-653 РА-653	50	123	19	19	
	ПУ-673 РА-673	250	57	14.2	7.8	3.3
	ПУ-674 РА-674	250	51	12.1	8.2	3
	ПУ-675 РА-675	100	130	50.5	7.4	
	ПУ-676 РА-676	100	136	16.3	13.8	
	ПУ-677 РА-677	20	440	50.5	23	



















Вид/ Item	Артикул/ Article	Кільк. м. у бухті/ M. on the coil	Вага г/м ±3%/ Weight g/m ±3%	Ширина/ Width	Висота/ Height	Шир. замка/ Width lock
	НП-009 NP-009	300	52	14.5	7	1.3
	НП-011 NP-011	250	64	10	14.4	
	НП-012 NP-012	250	59	13.8	12	4
	НП-014 NP-014	100	108	31.2	9.3	6.6
	НП-014/1 NP-014/1	100	101	30.1	8.3	6.5
	НП-015/12м NP-015/12m	300	36	12.2	4.2	7.5
	НП-015/11м NP-015/11m	300	38	11	4.2	7.8
	НП-016 NP-016	400	40	11.2	6.3	8.4
	НП-017 NP-017	350	45	19.8	3.92	8.9
	НП-018 NP-018	400	36	9.2	8.0	1.5
	НП-019 NP-019	250	50	13.6	6.1	5.6
	НП-020 NP-020	350	47	11.4	7.8	1.5
	НП-021 NP-021	350/100	45	10.6	9	1.6
	НП-022 NP-022	300	42	10.9	5.1	7.6
	НП-2201 NP-2201	300	39	11	4.9	6.9
	НП-023 NP-023	300	37	11.8	4.7	7















Вид/ Item	Артикул/ Article	Кільк. м. у бухті/ M. on the coil	Вага г/м ±3%/ Weight g/m ±3%	Ширина/ Width	Висота/ Height	Шир. замка/ Width lock
	НП-024 NP-024	300	46	14.1	6	1.1
	НП-25 NP-25	300	35	11.5		7.7
	НП-26 NP-26	300	46	14.1	5.0	
	НП-28 NP-28	300	35	11	4.3	8.0
	НП-29 NP-29	300	48	16.2	5.9	6
	НП-30 NP-30	300	46	15	7.1	2.6
	НП-31 NP-31	5/30(150)	76	Ø7.6		
	НП-32 NP-32	350	34	12.5	8.5	
	НП-33 NP-33	350	41	12.9	6.4	6
	НП-34 NP-34	300	44	16	6	5.7
	НП-35 NP-35	300	41	12.5	4.8	7
	НП-36 NP-36	350	44	13.3	7.3	1.5
	НП-3601 NP-3601	350/100	38	13.1	6.6	1.6
	НП-3602 NP-3602	300/100	42	13.3	6.5	
	НП-37 NP-37	250	36	10.8	4.5	8.6
	НП-38 NP-38	350	38	13	6	1.5



















Вид/ Item	Артикул/ Article	Кільк. м. у бухті/ M. on the coil	Вага г/м ±3%/ Weight g/m ±3%	Ширина/ Width	Висота/ Height	Шир. замка/ Width lock
	НП-39 NP-39	400/100	41	9.3	7.3	1.5
	НП-40 NP-40	200	69	9.7	12.4	
	НП-41 NP-41	300	38	10.3	4.2	
	НП-42 NP-42	350/200/100	46	13.5	6.6	1.7
	НП-43 NP-43	80	89	24	7.3	
	НП-44 NP-44	300/100	48	14.9	6.85	1.3
	НП-45 NP-45	350/100	43	13.4	6.7	1.4
	НП-46 NP-46	300	39	8	5.3	
	НП-48 NP-48	300	36	10.8	4.6	8.3
	НП-49 NP-49	300	40	12.5	4.8	7.8
	НП-50 NP-50	350/100	44	13.3	7.3	1.5
	НП-51 NP-51	300	37	10.8	4.5	8.6
	НП-53 NP-53	300	43	12.5	4.8	7
	НП-58 NP-58	300	38	11.6	4.7	8.3
	НП-5802 NP-5802	300	34	11.6	4.7	7.5
	НП-59 NP-59	300	42	10.4	3.9	















Вид/ Item	Артикул/ Article	Кільк. м. у бухті/ M. on the coil	Вага г/м ±3%/ Weight g/m ±3%	Ширина/ Width	Висота/ Height	Шир. замка/ Width lock
	НП-59/1 NP-59/1	300	54	11.6	4.5	
	НП-69 NP-69	300	36	11.7	4.5	7.5
	НП-73 NP-73	50	45	32.7	3.5	30.8
	НП-73/1 NP-73/1	50	44	32.55	3.4	30.7
	НП-75 NP-75	50				
	НП-76 NP-76	50	61	34.9	5.9	30.6
	НП-76/1 NP-76/1	50	55	33.3	5.5	29.1
	<p>Виготовляємо подібні конфігурації у різних розмірах, під замовлення, згідно з вимогами клієнта (Шор від 60А до 100А)</p>					
						
						
						
						
						





Вид/ Item	Артикул/ Article	Кільк. м. у бухті/ M. on the coil	Вага г/м ±3%/ Weight g/m ±3%	Ширина/ Width	Висота/ Height	Шир. замка/ Width lock
	ПУ-001 РА-001	200	70	13.7	13.5	6.5
	ПУ-006 РА-006	50	250	17.5	22	14
	ПУ-011 РА-011	150	98	17	9	14.3
	ПУ-012 РА-012	200	78	14.4	7	6.5
	ПУ-017 РА-017	250	59	12.5	7	5.5
	ПУ-022 РА-022	40	380	41.2	25	7.6
	ПУ-035 РА-035	50	270	23	25	
	ПУ-038 РА-038	100	180	58.6	6	
	ПУ-039 РА-039	500	30	8.2	7.8	4.2
	ПУ-041 РА-041	50	300	40	18	6
	ПУ-042 РА-042	250	60	13	6	
	ПУ-043 РА-043	200	79	18	10	6
	ПУ-051 РА-051	60	220	30	15	
	ПУ-053 РА-053	180	90	20.5	7.7	10.5
	ПУ-054 РА-054	70	220	31	21.5	6
	ПУ-059 РА-059	250	48	10.2	10.5	4.7



Вид/ Item	Артикул/ Article	Кільк. м. у бухті/ M. on the coil	Вага г/м ±3%/ Weight g/m ±3%	Ширина/ Width	Висота/ Height	Шир. замка/ Width lock
	ПУ-061 РА-061	250	70	13.5	13.5	6
	ПУ-630 РА-630	50	260	17.5	27	
	ПУ-631 РА-631	50	260	32.6	18	
	ПУ-1010 РА-1010	500	42	5.6	8	1.6
	ПУ-1011 РА-1011	500	36	5	8	1.6
	АВ-20 АВ-20	20	630	48	26	6
	АГ-30 АГ-30	60	411	37	40	17.5
	ВА-10 ВА-10	40	480	30	30	20
	ТР-7 ТР-7	50	350	31	20	13.5
	ТР-8 ТР-8	250	58	10	8	
	ТР-9 ТР-9	70	205	21	16	6
	ША-002 SH-002	200/1000	14	Ø3		
	ША-003 SH-003	200/1000	15	Ø4		







Вид/ Item	Артикул/ Article	Quantity	Вага г/м ±3%/ Weight g/m ±3%	Size
	МД-01 MD-01	4	105	R13-R18
	МД-01 MD-01	4	105	R16-R18
	МД-01 MD-01	4	105	R19-R21
	МД-01 MD-01	4	105	R22-R23







Вид/ Item	Артикул/ Article	Кільк. м. у бухті/ M. on the coil	Вага г/м ±3%/ Weight g/m ±3%	Ширина/ Width	Висота/ Height	Шир. замка/ Width lock
--------------	---------------------	--------------------------------------	---------------------------------	------------------	-------------------	---------------------------



ЗАГЛУШКА ДО ПАЗУ (БРУДОЗАХИСНА)/PLUG FOR GROOVE (ANTI-SPLASH)

	КА-001 КА-001	100/400	65	12.5	8	6.5
	КА-002 КА-002	100/400	24	6	6.5	5
	КА-004 КА-004	100/400	20	9.4	4.9	5
	КА-005 КА-005	500	24	6.7	6.9	6.3

УЩІЛЬНЮВАЧ ДВЕРНОГО БЛОКУ/DOOR BLOCK SEAL STRIPS

	КА-006 КА-006	80	145	15.2	23	14
	КА-006/01 КА-006/01	100	132	15.2	21.3	13.5
	КА-008 КА-008	200	69	17	10.7	
	КА-014 КА-014	80	141	15.7	24.5	

АГРОШНУР/CAMBRIC TUBE



	АШ-005 ASH -005	185/920	5.4	Ø3		
	АШ-006 ASH -006	105/530	9.3	Ø4		
	АШ-007 ASH -007	70/345	14.4	Ø5		



УЩІЛЬНЮВАЧ ПІДСТАВОЧНОГО ПРОФІЛЮ/PEDESTAL PROFILE SEAL STRIP

	КА-012 КА-012	400	26	7.5	9.7	5.5
---	-------------------------	------------	-----------	------------	------------	------------





Вид/ Item	Артикул/ Article	Кільк. м. у бухті/ M. on the coil	Вага г/м ±3%/ Weight g/m ±3%	Ширина/ Width	Висота/ Height	Шир. замка/ Width lock
--------------	---------------------	--------------------------------------	---------------------------------	------------------	-------------------	---------------------------

ТРУБКА ПВХ ПРОЗОРА/TRANSPARENT PVC PIPE						
	КТ-1 КТ-1	50	-	під замовлення/ under the order		
	КТ-2 КТ-2	200	-	під замовлення/ under the order		

УЩІЛЬНЮВАЧ ДЛЯ ТРЕТЬОГО КОНТУРУ/SEAL STRIP FOR FIVE-CHAMBER WINDOW SYSTEM						
	КА-003 КА -003	200	43	9.5	20.5	5
	КА-007 КА -007	200	49	9	22	5

КАНТ ДЛЯ СОВКА/SCOOP EDGING						
	СО-9001 СО-9001	2.1x100 шт	47	18.9	4.5	

















УЩІЛЬНЮВАЧ РІЗНОГО ПРИЗНАЧЕННЯ/SEAL STRIPS FOR VARIOUS PURPOSES						
	АШ-100 ASH-100	1000	15	Ø4		
	ФД-011 FD-011	500	124	20.2	19.5	11

ОБРАМЛЕННЯ СКЛА/GLASS FRAMING						
	ПУ-652 РА-652	250	70	9.6	9.6	3.8





Вид/ Item	Артикул/ Article	Кільк. м. у бухті/ M. on the coil	Вага г/м ±3%/ Weight g/m ±3%	Кільк. зуб. Number of teeth	Діаметр Diameter
--------------	---------------------	--------------------------------------	---------------------------------	--------------------------------	---------------------

ШНУР ДЛЯ АНТИМОСКІТНИХ СИСТЕМ/SCREENING SPLINE









	КА-310 КА-310	150/600	14	12	Ø 4
	КА-310 КА-310	150/600	17	12	Ø 4.3
	КА-310 КА-310	150/600	18	12	Ø 4.5
	КА-310 КА-310	150/600	18	12	Ø 4.7
	КА-310 КА-310	150/600	18	12	Ø 4.8
	КА-310 КА-310	150/600	21	12	Ø 5
	КА-310 КА-310	150/600	23	12	Ø 5.3
	КА-310 КА-310	150/600	18	22	Ø 4.3
	КА-310 КА-310	150/600	20	22	Ø 4.7
	КА-310 КА-310	150/600	25	22	Ø 5
	КА-3101 КА-3101	150/600	16	22	Ø 5
	КА-310 КА-310	150/600	25	22	Ø 5.3
	КА-310 КА-310	150/600	33	22	Ø 5.8
	КА-310 КА-310	150/600	32	22	Ø 6
	КА-310 КА-310	150/300	49	22	Ø 7
	КА-310 КА-310	100/300	58	22	Ø 8



Вид/ Item	Артикул/ Article	Кільк. м. у бухті/ M. on the coil	Вага г/м ±3%/ Weight g/m ±3%	Ширина/ Width	Висота/ Height	Шир. замка/ Width lock
	КА-010 КА-010	350	10	5	3.6	1.2
	КА-010 КА-010	350	13	5.3	3.6	1.2







Вид/ Item	Артикул/ Article	Кільк. м. у бухті/ M. on the coil	Вага г/м ±3%/ Weight g/m ±3%	Ширина/ Width	Висота/ Height	Шир. замка/ Width lock
--------------	---------------------	--------------------------------------	---------------------------------	------------------	-------------------	---------------------------

ДЛЯ МЕБЛЕВОЇ ФУРНІТУРИ/SEAL STRIPS FOR FURNITURE FITTINGS						
	МФ-004 MF-004	300	51	9.2	5.2	2.2
	МФ-005 MF-005	200	80	8.7	12.6	
	МФ-006 MF-006	під замовлення/ under the order	40	13.8	4.7	3.3
	МФ-007 MF-007	під замовлення/ under the order	40	13.4	5.7	4.3
	МФ-08 MF-008	під замовлення/ under the order	53	11.3	5.7	3.3
	МФ-14 MF-14	під замовлення/ under the order	26	13.2	4.5	8.7
	МФ-17 MF-17	під замовлення/ under the order	15	13.7	4.2	13.3
	МФ-17/1 MF-17/1	під замовлення/ under the order	14	13	3.9	12.8









Вид/ Item	Артикул/ Article	Кільк. м. у бухті/ M. on the coil	Вага г/м ±3%/ Weight g/m ±3%	Ширина/ Width	Висота/ Height	Шир. замка/ Width lock
--------------	---------------------	--------------------------------------	---------------------------------	------------------	-------------------	---------------------------

ДЛЯ МДФ ПРОФІЛЮ/SEAL STRIPS FOR MDF PROFILE						
	ДР-713 DR-713	100/400	35	7.5	8	
	ДР-713/1 DR-713/1	100/400	39	8	8	
	ПУ-625 PA-625	100/400	51	9	7	
	ПУ-625/1 PA-625/1	100/400	58	10.2	8.2	
	ПУ-669 PA-669	100/500	26	6.7	4.7	







Вид/ Item	Артикул/ Article	Кільк. м. у бухті/ M. on the coil	Вага г/м ±3%/ Weight g/m ±3%	Ширина/ Width	Висота/ Height	Шир. замка/ Width lock
--------------	---------------------	--------------------------------------	---------------------------------	------------------	-------------------	---------------------------

ДЛЯ РОЛЕТНИХ СИСТЕМ/FOR ROLLER SHUTTER SYSTEMS						
	CA-31 CA-31	350	19	7.2	4.6	1.8
	CA-32 CA-32	350	26	11.7	4.3	5.4
	CA-33 CA-33	350	26	7	7	4.6
	CA-36 CA-36	під замовлення/ under the order	106	50.5	9	3.28
	CA-36 CA-36	під замовлення/ under the order	116	50.5	9	3.28
	CA-507 CA-507	200	22	8	6.4	5.2



Вид/ Item	Артикул/ Article	Кільк. м. у бухті/ M. on the coil	Вага г/м ±3%/ Weight g/m ±3%	Ширина/ Width	Висота/ Height	Шир. замка/ Width lock
--------------	---------------------	--------------------------------------	---------------------------------	------------------	-------------------	---------------------------

ПВХ ПРОФІЛЬ СТІНОВИЙ/PVC WALL PROFILE						
	СП-230 SP-230	2.5x40 ШТ. (100 м.п)	155	29.3	9.5	4.5
	СП-232 SP-230 shadow	2.5x40 ШТ. (100 м.п)	137	27.5	9.5	4.5
	СП-330 SP-330 standard	2.5x40 ШТ. (100 м.п)	150	26.4	10	5.36
	СП-331 SP-331 premium	2.5x40 ШТ. (100 м.п)	150	26.4	10	5.36
	СП-332 SP-332	2.5x40 ШТ. (100 м.п)	140	29.3	9.6	



НА КЛЕЄВІЙ ОСНОВІ/У ПАЗ

SELF-ADHESIVE/WITHOUT GLUE

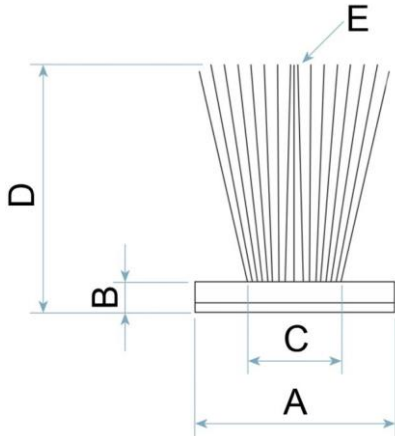

A - (ширина основи/base width)

6,7±0,20 мм

B - (висота основи/base thickness)

0,8±0,20 мм

C - (ширина основи ворсу/pile width)

2L: 2±0,20 мм; 3L 3±0,20 мм

D - (загальна висота/total height)

4≤D≤17±0,20 мм (з інтервалом 1 мм/spaced 1 mm)

E - (щільність ворсу/pile density)

2P2L; 3P2L; 3P3L; 4P2L

НА КЛЕЄВІЙ ОСНОВІ/У ПАЗ

SELF-ADHESIVE/WITHOUT GLUE

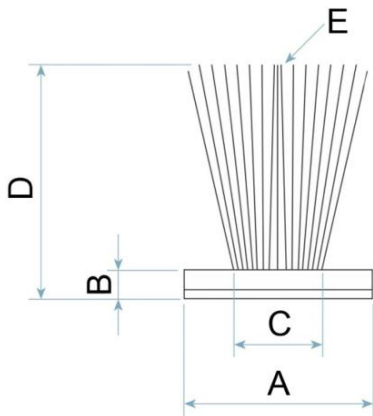

A - (ширина основи/base width)

4,8±0,20 мм

B - (висота основи/base thickness)

0,8±0,20 мм

C - (ширина основи ворсу/pile width)

2±0,20 мм

D - (загальна висота/total height)

4≤D≤17±0,20 мм (з інтервалом 1 мм/spaced 1 mm)

E - (щільність ворсу/pile density)

У ПАЗ

WITHOUT GLUE

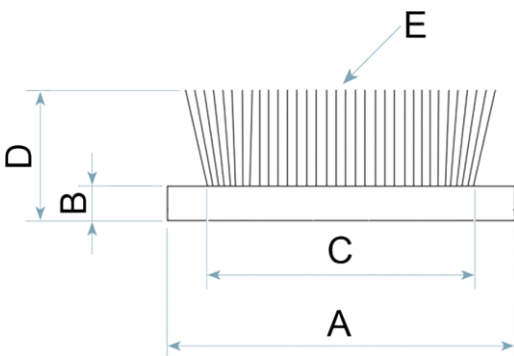

A - (ширина основи/base width)

14±0,20 мм

B - (висота основи/base thickness)

0,8±0,20 мм

C - (ширина основи ворсу/pile width)

9±0,20 мм

D - (загальна висота/total height)

4≤D≤17±0,20 (з інтервалом 1 мм/ spaced 1 mm)

E - (щільність ворсу/pile density)

8P8L

Виготовлено згідно ТУ У 13.9-36574851-001:2017/Manufactured according to TU U 13.9-36574851-001:2017

УЩІЛЬНЮВАЧ НА ЖОРСТКОМУ ЕКСТРУДОВАНОМУ УТРИМУВАЧІ ДЛЯ ВСТАНОВЛЕННЯ В ПАЗ-ПРОПИЛ

PILE WEATHERSTRIP ON A RIGID EXTRUDED HOLDER FOR INSTALLATION IN A GROOVE

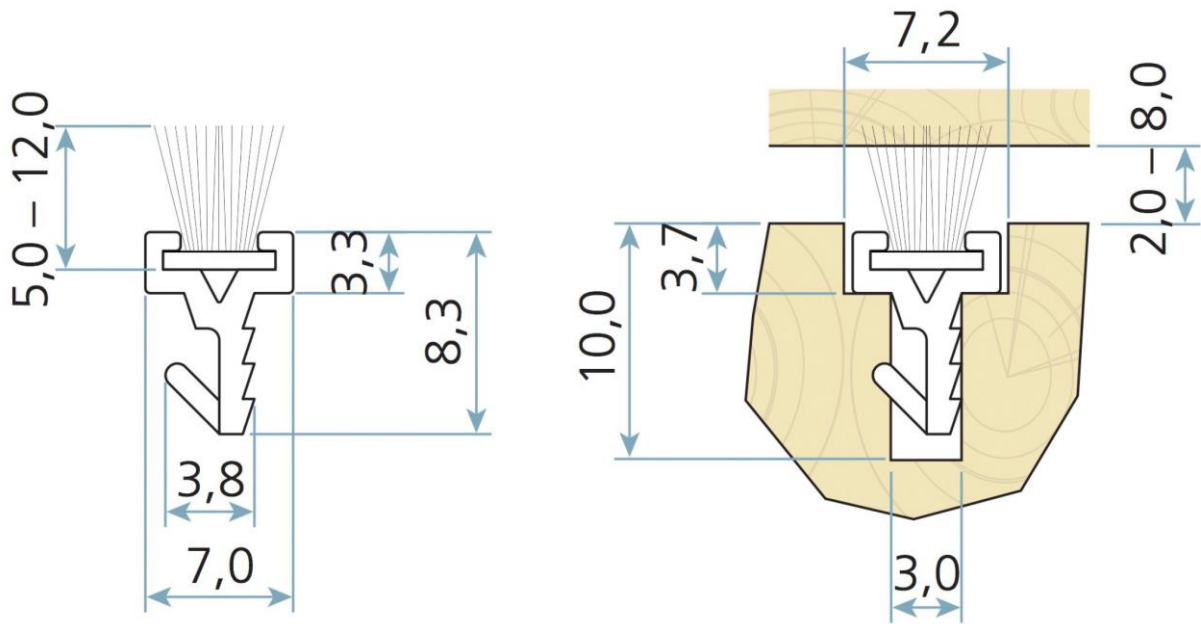

Виготовлено згідно ТУ У 13.9-36574851-001:2017/Manufactured according to TU U 13.9-36574851-001:2017



НАШІ
КОНТАКТИ

Україна, м. Дніпро, вул. Молодогвардійська, 6
+38 097 300 72 97
sales@kiplast.com.ua - відділ продажу
kiplast.com.ua

CONTACTS

Ukraine, Dnipro, Molodogvardeyskaya st., 6
+380 96 753 53 93
sales@kiplast.com.ua - sales department
kiplast.com.ua

